

# Green Power , Green World !

## Main Markets



**XIAMEN UNIVERSE SOLAR TECHNOLOGY CO.,LTD**

Add.: NO.146, 6TH FLOOR, UNIT3, 2ND PLANT, JIMEI DISTRICT, XIAMEN, CHINA

Web: [www.uisolar.com](http://www.uisolar.com) Email: [info@uisolar.com](mailto:info@uisolar.com)

Tel: +86-592-566-3849 Fax: +86-592-517-0790

**SOLAR** Solar Panel Brackets  
PV MOUNTING SOLUTIONS





# Company Profile

••• Universe Solar (UISOLAR) is a high-tech enterprise specializing in the development, manufacturing, and marketing of photovoltaic racking solutions, including Pitched Roof Mounting Solutions, Flat Roof Mounting Solutions, Ground Mounting (both for Aluminum and Steel) Solutions and Solar Carport.

With the Principle of "Innovative, Environment Friendliness and Responsibility", UISOLAR set up in 2010 in Xiamen, China.

In order to provide the high quality and easy installation products, all the products offered after the strength calculation and tested by QC before delivery, and most of the products are pre-assembled before the shipment to save the installation time.

With our top quality and service, UISOLAR mountings are welcomed by most of the installers, distributors, and EPC ect.all around the world.



## Why UISOLAR?

### ••• 01 Reasonable design and solution

All the solution will be designed based on strict strength calculation.

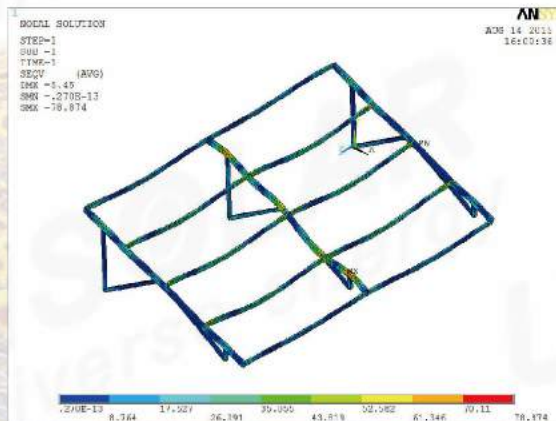

### ••• 02 High Quality

All the goods will be tested before delivery and most of the goods will be pre-assembled.

### ••• 03 Best Service

We will response to you within 24H.for any feedback both before and after sales.

### ••• 04 Certificate Support

For Customer's need, we have got so many certificates and inspections for our products.



# Content



#### Components

01-08

#### Pitched Tile Roof Mounting

09-10

#### Pitched Tin Roof Mounting

11-12

#### Trapezoidal Roof Mounting

13-14

#### Standing Seam Roof Mounting

15-16

#### Thin Film Panel Tin Roof Mounting

17-18

#### Aluminum Ballasted Mounting

19-20

#### Flat Tin Roof Mounting

21-22

#### SS05&Aluminum Triangle mounting

23-24

#### Solar Aluminum Carport Mounting

25-26

#### Four Poles Carport Mounting

27-28

#### ST2 Pile Ground Mounting

29-30

#### ST3E Aluminum Ground Mounting

31-32

#### Solar Farm

33-34

#### Ground Screw

35-38

#### Project

39-40

#### Certificate & PV Show

41-42

#### Packing & Voice

43-44





# Production Line







Annually Production  
Capacity : **800MW**  
Solar Mountings





## Tile Roof Hooks

UI-IK-01



ITEM NO.	MATERIAL	SPEC.	WEIGHT	SURFACE
UI-IK-01	SUS 304	Plate:180*50	566.5 g	Sandblasted
Fix Rail To Roman Tile Roof (20pcs/carton)				

UI-IK-02



ITEM NO.	MATERIAL	SPEC.	WEIGHT	SURFACE
UI-IK-02	SUS 304	-	501.5 g	Sandblasted
Fix Rail To Flat Tile Roof (30pc/carton)				

UI-IK-04



ITEM NO.	MATERIAL	SPEC.	WEIGHT	SURFACE
UI-IK-04	SUS 304	Plate:180*50	562 g	Sandblasted
Fix Rail To Roman Tile Roof (20pcs/carton)				

UI-IK-05



ITEM NO.	MATERIAL	SPEC.	WEIGHT	SURFACE
UI-IK-05	SUS 304	-	389.5 g	Sandblasted
Fix Rail To Asphalt Tile Roof (50pcs/carton)				

UI-IK-06



ITEM NO.	MATERIAL	SPEC.	WEIGHT	SURFACE
UI-IK-06	SUS304	-	929 g	Sandblasted
Fix Rail to Roman Tile Roof(9pcs/carton)				

UI-IK-07



ITEM NO.	MATERIAL	SPEC.	WEIGHT	SURFACE
UI-IK-07	SUS 304	Plate:150*60	666.7 g	Sandblasted
Fix Rail To Roman Tile Roof (24pcs/carton)				

UI-IK-08



ITEM NO.	MATERIAL	SPEC.	WEIGHT	SURFACE
UI-IK-08	SUS 304	Plate:140*54	676 g	Sandblasted
Fix Rail To Roman Tile Roof (20pcs/carton)				

UI-IK-09



ITEM NO.	MATERIAL	SPEC.	WEIGHT	SURFACE
UI-IK-09	SUS 304	Plate:140*54	720 g	Sandblasted
Fix Rail To Roman Tile Roof (25pcs/carton)				

UI-IK-11



ITEM NO.	MATERIAL	SPEC.	WEIGHT	SURFACE
UI-IK-11	SUS 304	Plate:140*54	740 g	Sandblasted
Fix Rail To Roman Tile Roof (25pcs/carton)				



## » Rails

UI-R1



ITEM NO.	MATERIAL	SPEC.	WEIGHT	SURFACE
UI-R1-2560	Al 6005-T5	2560mm	2690 g	Anodized
UI-R1-3405	Al 6005-T5	3405mm	3580 g	Anodized
UI-R1-4200	Al 6005-T5	4200mm	4410 g	Anodized
UI-R1	Al 6005-T5	Customized	-	Anodized

UI-R2



ITEM NO.	MATERIAL	SPEC.	WEIGHT	SURFACE
UI-R2-2560	Al 6005-T5	2560mm	2230 g	Anodized
UI-R2-3405	Al 6005-T5	3405mm	2960 g	Anodized
UI-R2-4200	Al 6005-T5	4200mm	3650 g	Anodized
UI-R2	Al 6005-T5	Customized	-	Anodized

UI-R4



ITEM NO.	MATERIAL	SPEC.	WEIGHT	SURFACE
UI-R4-2560	Al 6005-T5	2560mm	3280 g	Anodized
UI-R4-3405	Al 6005-T5	3405mm	4360 g	Anodized
UI-R4-4200	Al 6005-T5	4200mm	5380 g	Anodized
UI-R4	Al 6005-T5	Customized	-	Anodized

UI-R6



ITEM NO.	MATERIAL	SPEC.	WEIGHT	SURFACE
UI-R6-2560	Al 6005-T5	2560mm	2480 g	Anodized
UI-R6-3405	Al 6005-T5	3405mm	3300 g	Anodized
UI-R6-4200	Al 6005-T5	4200mm	4700 g	Anodized
UI-R6	Al 6005-T5	Customized	-	Anodized

UI-R13



ITEM NO.	MATERIAL	SPEC.	WEIGHT	SURFACE
UI-R13	Al 6005-T5	1000mm	685 g	Anodized

UI-R-SP



ITEM NO.	MATERIAL	SPEC.	WEIGHT	SURFACE
UI-R-SP	Al 6005-T5	190mm	105 g	Anodized

## » Framed panel clamps

UI-IC



ITEM NO.	MATERIAL	SPEC.	WEIGHT	SURFACE
UI-IC-35	Al 6005-T5	35mm	58.0 g	Anodized
UI-IC-40/42	Al 6005-T5	40/42mm	59.6 g	Anodized
UI-IC-45/46	Al 6005-T5	45/46mm	62.0 g	Anodized
UI-IC-50	Al 6005-T5	50mm	62.8 g	Anodized

UI-EC



ITEM NO.	MATERIAL	SPEC.	WEIGHT	SURFACE
UI-EC-35	Al 6005-T5	35mm	50.4 g	Anodized
UI-EC-40	Al 6005-T5	40mm	52.8 g	Anodized
UI-EC-42	Al 6005-T5	42mm	54.4 g	Anodized
UI-EC-45	Al 6005-T5	45mm	55.0 g	Anodized
UI-EC-46	Al 6005-T5	46mm	55.1 g	Anodized
UI-EC-50	Al 6005-T5	50mm	56.8 g	Anodized

UI-IC (C)



ITEM NO.	MATERIAL	SPEC.	WEIGHT	SURFACE
UI-IC(C)-35	Al 6005-T5	35mm	53.8 g	Anodized
UI-IC(C)-40	Al 6005-T5	40mm	55.6 g	Anodized
UI-IC(C)-45	Al 6005-T5	45mm	57.0 g	Anodized
UI-IC(C)-50	Al 6005-T5	50mm	58.6 g	Anodized

UI-EC (C)



ITEM NO.	MATERIAL	SPEC.	WEIGHT	SURFACE
UI-EC(C)-35	Al 6005-T5	35mm	50.6 g	Anodized
UI-EC(C)-40	Al 6005-T5	40mm	52.5 g	Anodized
UI-EC(C)-45	Al 6005-T5	45mm	56.2 g	Anodized
UI-EC(C)-50	Al 6005-T5	50mm	59.4 g	Anodized

UI-AE



ITEM NO.	MATERIAL	SPEC.	WEIGHT	SURFACE
UI-AE	Al 6005-T5	35-50mm	65.0 g	Anodized
UI-AE2	Al 6005-T5	30-45mm	63.0 g	Anodized



## » New Upgrade

UI-IC (N)



NEW!

ITEM NO.	MATERIAL	SPEC.	WEIGHT	SURFACE
UI-IC(N)-30	Al 6005-T5	30mm	49.9 g	Anodized
UI-IC(N)-35	Al 6005-T5	35mm	51.6 g	Anodized
UI-IC(N)-40	Al 6005-T5	40mm	53.1 g	Anodized
UI-IC(N)-45	Al 6005-T5	45mm	54.6 g	Anodized
UI-IC(N)-50	Al 6005-T5	50mm	55.8 g	Anodized

UI-IK-L



ITEM NO.	MATERIAL	SPEC.	WEIGHT	SURFACE
UI-IK-L-125	Al 6005-T5	125mm	-	Anodized
UI-IK-L-80	Al 6005-T5	84mm	-	Anodized

## » Thin film solar clamps

UI-IC-Type3



ITEM NO.	MATERIAL	SPEC.	WEIGHT	SURFACE
UI-IC-Type3	Al 6005-T5	For Thin Film Panel (No Bolt, No Nut)	-	Anodized

UI-EC-Type3



ITEM NO.	MATERIAL	SPEC.	WEIGHT	SURFACE
UI-EC-Type3	Al 6005-T5	For Thin Film Panel (No Bolt, No Nut)	-	Anodized

## » Grounding Components

UI-GW



ITEM NO.	Description	Material	WEIGHT	SURFACE
UI-GW	Grounding Washer	SUS 304	3.6 g	Clean

UI-GL



ITEM NO.	Description	Material	WEIGHT	SURFACE
UI-GL	Grounding Lug	Al 6005-T5& SUS 304	36.6 g	Clean

UI-BJ



ITEM NO.	Description	Material	WEIGHT	SURFACE
UI-BJ	Bonding Jumper	Copper&Steel	75.8 g	Clean

## » Cable Clips

UI-CC1



ITEM NO.	MATERIAL	SPEC.	WEIGHT	SURFACE
UI-CC1	SUS 304	1~2 cables	2.5 g	Clean

UI-CC2



ITEM NO.	MATERIAL	SPEC.	WEIGHT	SURFACE
UI-CC2	SUS 304	3~4 cables	5.5 g	Clean

UI-CC3



ITEM NO.	MATERIAL	SPEC.	WEIGHT	SURFACE
UI-CC3	SUS304	1~2 cables	4.3g	Clean



## » Clamping Hooks

UI-TR-01-N



ITEM NO.	MATERIAL	SPEC.	WEIGHT	SURFACE
UI-TR-01-N	Al 6005-T5	Tin Roof	215 g	Anodized

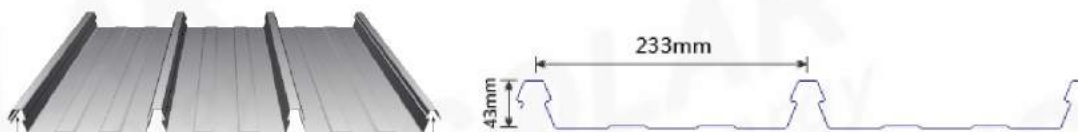

UI-TR-08



ITEM NO.	MATERIAL	SPEC.	WEIGHT	SURFACE
UI-TR-08	Al 6005-T5	Tin Roof	176 g	Anodized



UI-TR-03



ITEM NO.	MATERIAL	SPEC.	WEIGHT	SURFACE
UI-TR-03	SUS 304	Tin Roof	460 g	Sandblasted



UI-TR-09-N



ITEM NO.	MATERIAL	SPEC.	WEIGHT	SURFACE
UI-TR-09-N	Al 6005-T5	Tin Roof	-	Anodized

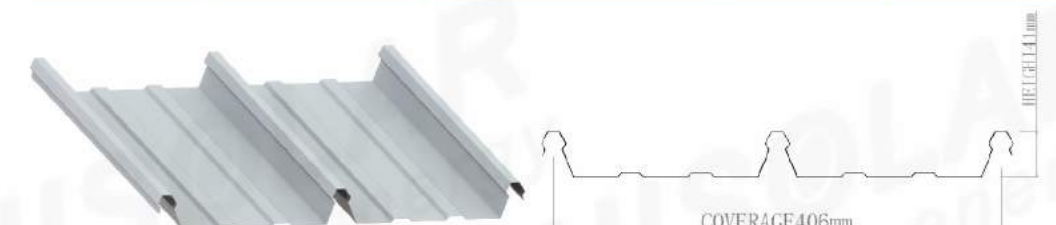

UI-TR-04-N



ITEM NO.	MATERIAL	SPEC.	WEIGHT	SURFACE
UI-TR-04-N	Al 6005-T5	Tin Roof	270 g	Anodized

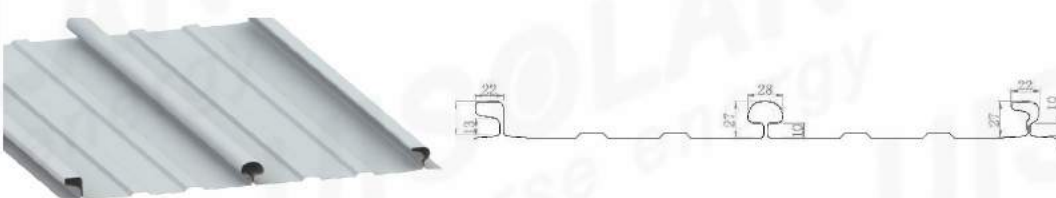

UI-TR-10



ITEM NO.	MATERIAL	SPEC.	WEIGHT	SURFACE
UI-TR-10	Al 6005-T5	Tin Roof	150 g	Anodized



UI-TR-07-N



ITEM NO.	MATERIAL	SPEC.	WEIGHT	SURFACE
UI-TR-07-N	Al 6005-T5	Tin Roof	-	Anodized



UI-SS05

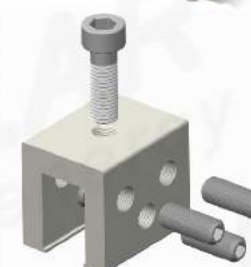

ITEM NO.	MATERIAL	SPEC.	WEIGHT	SURFACE
UI-SS05	Al 6005-T5	-	120 g	Anodized





# ▶ Pitched Tile Roof Mounting

Pitched Tile Roof Mounting designs with great flexibility both for commercial and residential roof solar system. Patented and Innovative rail design, standard components, Highly pre-assembled clamp, all the above make the installation simple. Save your installation time and cost.



## ■ Brief Introduction

- Installation Site: Pitched tile Roof;
- Max. Building Height: up to 65ft(22m), customized available;
- Max. Wind Speed: **60** m/s;
- Snow Load: **1.4** KN/m<sup>2</sup>;
- Material: Aluminum 6005-T5 & Stainless Steel 304;
- Warranty: **10** years warranty; **25** years service life;
- Standard AS/NZS 1170.

## ■ Tile Hook Types



## ■ Components Parts

<p><b>A</b>      <b>UI-IC</b></p> <p>◆ Description Mid Clamp, Al 6005-T5&amp; SUS 304</p> <p>◆ Function Fix panel on the rail in the inner part</p>	<p><b>B</b>      <b>UI-EC</b></p> <p>◆ Description End Clamp, Al 6005-T5&amp; SUS 304</p> <p>◆ Function Fix panel on the rail at the end of panel</p>	<p><b>C</b>      <b>UI-IK-01</b></p> <p>◆ Description Tile Roof Hook, Stainless Steel SUS 304</p> <p>◆ Function Fix the rail to the beam</p>
<p><b>D</b>      <b>UI-R</b></p> <p>◆ Description Rail: Extruded Aluminum Profile, Al 6005-T5, 2560mm, 3405mm and 4200mm are the standard size</p> <p>◆ Function The frame supports the solar panel</p>	<p><b>E</b>      <b>UI-R-SP</b></p> <p>◆ Description Rail Splice, Al 6005-T5&amp; SUS 304</p> <p>◆ Function Extend the rail to the required length</p>	

## ■ Brief Installation Guide

<p><b>1</b> Remove the roof tiles and fix hooks to beam</p>	<p><b>2</b> Fix rails to the hooks</p>	<p><b>3</b> Put panels onto the rails and fix with clamps</p>	<p><b>4</b> Finished the installation</p>

## ■ Packing





# ➤ Pitched Tin Roof Mounting

Uisolar Pitched Tin roof mounting is designed with great flexibility for both commercial and residential roof solar systems. Patented and Innovative Rail design, standard components, Highly pre-assembled clamps, all the above make the installation simple. Save your time and your installation cost.

Advantages:

1. Lower cost, Incomparable value ;
2. Faster installation, Flexible attachment;
3. More perfect service, Complete technical support.



## ■ Brief Introduction

- Installation Site: Pitched Tin Roof
- Max. Building Height: up to 65ft(22m), customized available;
- Max. Wind Speed: **60** m/s;
- Snow Load: **1.4** KN/m<sup>2</sup>
- Material: Aluminum 6005-T5 & Stainless Steel 304;
- Warranty: **10** years warranty; **25** years service life.

## ■ Components Parts

 <p><b>UI-C</b>                  ◆ Description                  Mid clamp, Al 6005-T5&amp; SUS 304                  ◆Function                  Fix panel on the rail in the inner part</p>	 <p><b>UI-EC</b>                  ◆ Description                  End clamp, Al 6005-T5&amp; SUS 304                  ◆Function                  Fix panel on the rail at the end of panel</p>
 <p><b>UI-IK-L</b>                  ◆ Description                  L feet, Al6005-T5                  ◆Function                  Fix the rail to the beam</p>	 <p><b>UI-R</b>                  ◆ Description                  Rail: Extruded Aluminum Profile, Al6005-T5                  2560mm, 3405mm and 4200mm are the standard size                  ◆Function                  The frame supports the solar panel</p>

## ■ Other related Hook



## ■ Different types of connection



## ■ Application Roof

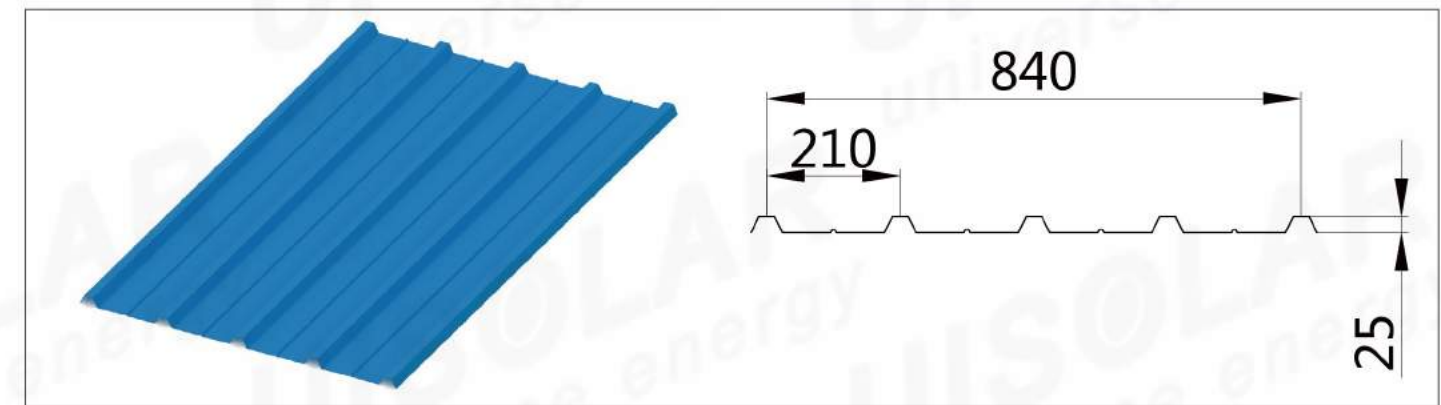

## ■ Brief Installation Guide

<p><b>1</b> Install the L feet to the roof sheet</p>	<p><b>2</b> Fix Rails to the L feet</p>	<p><b>3</b> Put the panels onto the rails and fix with mid clamps and end clamps</p>	<p><b>4</b> Finished the installation</p>
			



## » Trapezoidal Roof Mounting

SS-04 mounting kit is designed for trapezoidal shape metal roof sheet.  
 It can be fixed on roof directly without aluminum rails to save cost. Easy installation and wide range of application make it to be a worldwide hot product.



■ Trapezoidal roof specification

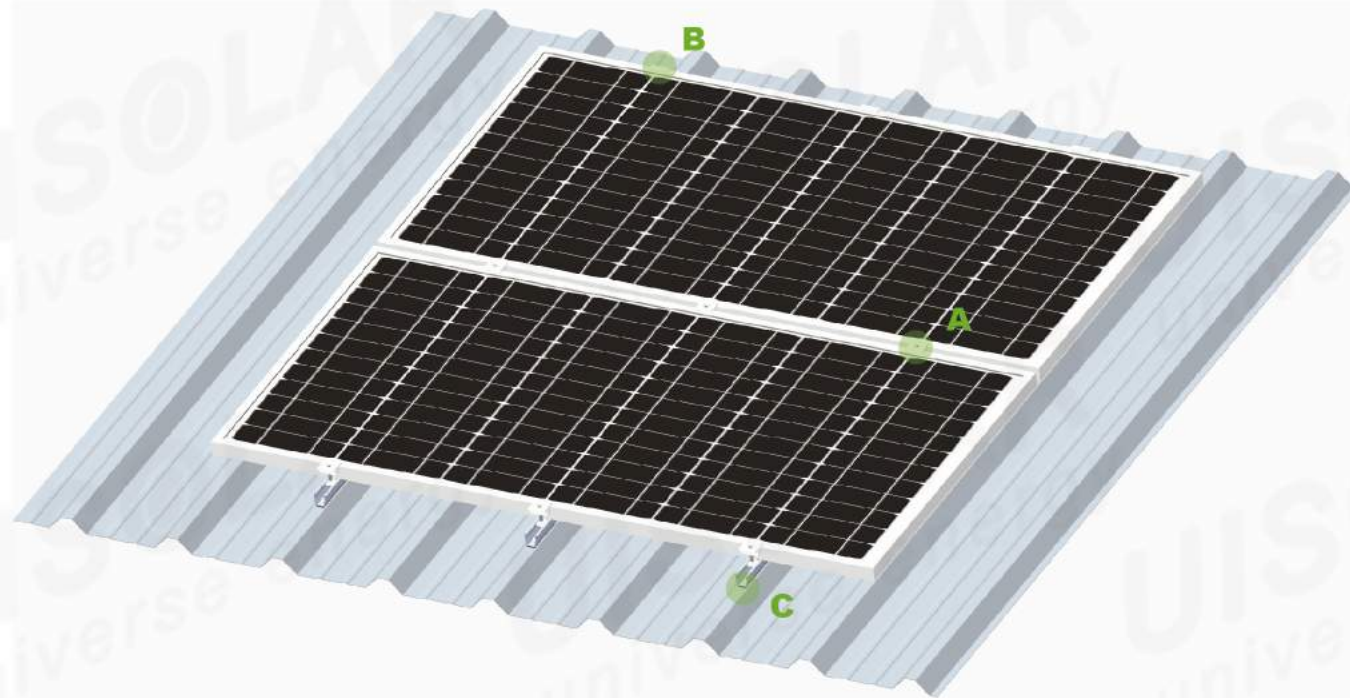

### ■ Components Parts

<p><b>A</b></p> <p><b>UI-IC</b></p> <p>◆ Description Mid clamp, Al 6005-T5&amp; SUS 304</p> <p>◆ Function Fix panel on the rail in the inner part</p>	<p><b>B</b></p> <p><b>UI-EC</b></p> <p>◆ Description End clamp, Al 6005-T5&amp; SUS 304</p> <p>◆ Function Fix panel on the rail at the end of panel</p>	<p><b>C</b></p> <p><b>UI-SS-04</b></p> <p>◆ Description SS04 hook, Al 6005-T5</p> <p>◆ Function Support Panels</p>
---	---	--

### ■ Brief Introduction

- SS-04 kit will be installed on the trapezoidal part "a" of the trapezoidal metal roof.
- The length of "a" should be more than **20mm**
- Fixing: SS-04 will be fixed on roof with 3 pcs self tapping screws
- Building Height: Less than **22m**(65 feet)
- Material: Aluminum 6005-T5
- Warranty: **10** years warranty; **25** years service life.

### ■ Brief Installation Guide

<p><b>1</b></p> <p>Position the installation point with UI-SS-04</p>	<p><b>2</b></p> <p>Fix the hook to the roof sheet with self tapping screws</p>	<p><b>3</b></p> <p>Put the panels onto UI-SS-04 hook and fix with clamps</p>	<p><b>4</b></p> <p>Finished the installation</p>

### ■ Application Roof

SS-04 mounting kit is used for industrial metal sheet roof with a trapezoidal shape.  
 The trapezoidal rib should be more than 20mm

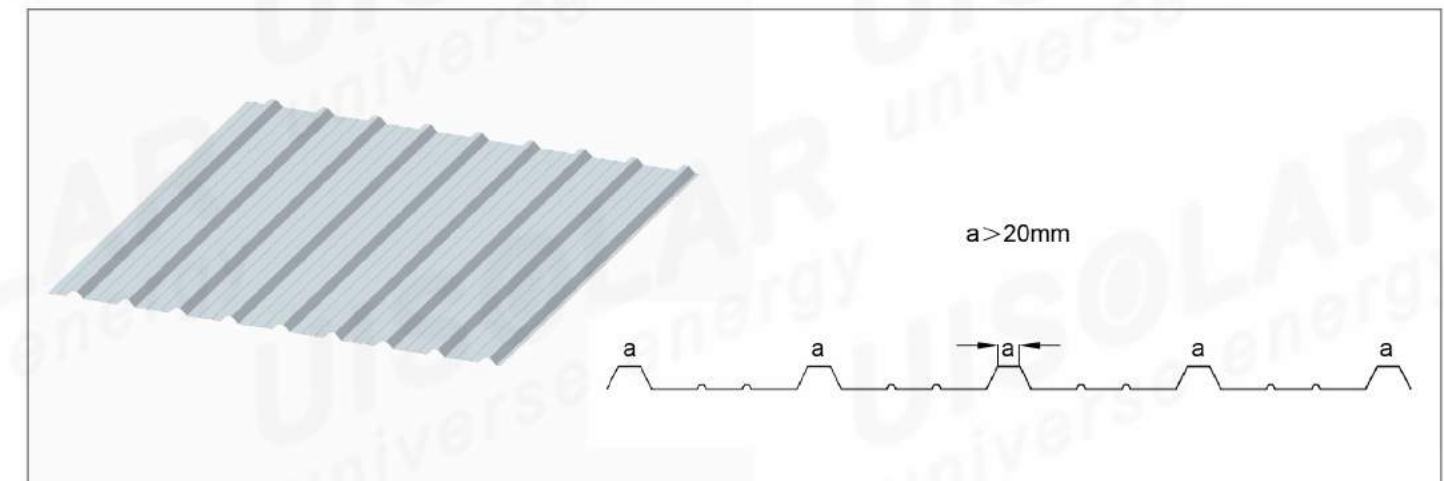



# Standing Seam Roof Mounting

Standing Seam Roof Mounting is a patented and innovative clamping roof mounting with great flexibility both for Commercial and Residential areas. No need of rail makes the installation to be easier and lower cost.



## Brief Introduction

- Installation Site: Metal Roof
- Max. Building Height: up to 65ft(22m), customized available;
- Max. Wind Speed: **60** m/s;
- Snow Load: **1.4** KN/m<sup>2</sup>
- Material: Aluminum 6005-T5 & Stainless Steel 304;
- Warranty: **10** years warranty; **25** years service life.

## Components Parts

<p><b>A</b></p>  <p><b>UI-IC</b>                  ◆ Description                  Mid clamp, Al 6005-T5&amp; SUS 304                  ◆Function                  Fix panel on the rail in the inner part</p>	<p><b>B</b></p>  <p><b>UI-EC</b>                  ◆ Description                  End clamp, Al 6005-T5&amp; SUS 304                  ◆Function                  Fix panel on the rail at the end of panel</p>	<p><b>C</b></p>  <p><b>TR-01-N</b>                  ◆ Description                  Standing seam roof clamp, AL 6005-T5&amp; SUS304                  ◆Function                  Fix onto the tin roof to support the solar panels</p>
--	--	--

## UI-TR Series

- UI-TR series standing seam clamp is used to fix the rail to the raised metal sheet on the roof, which is fastened by the screws **without penetrating** the roof structure surface.



ITEM NO.	Material	Spec.	WEIGHT	SURFACE
UI-TR-01-N	Al6005-T5	Tin Roof	215g	Anodized
UI-TR-04-N	Al6005-T5	Tin Roof	270g	Anodized
UI-TR-07-N	Al6005-T5	Tin Roof	420g	Anodized
UI-TR-08	Al6005-T5	Tin Roof	176g	Anodized

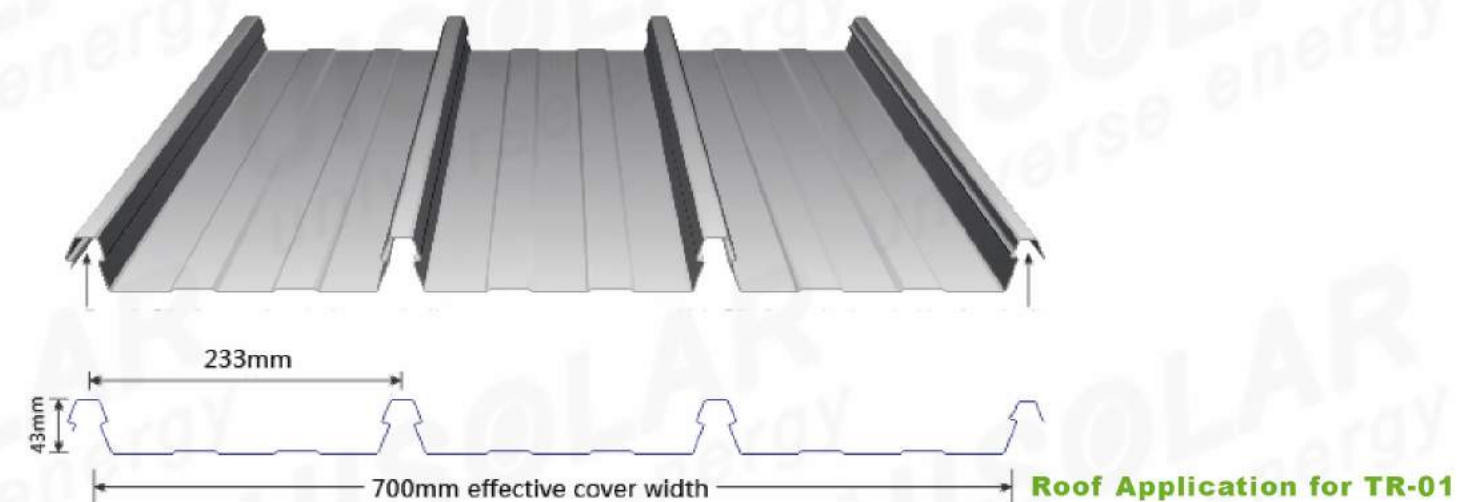

## Brief Installation Guide (Take UI-TR-01-N as example)

<p><b>1</b></p> <p>Fix the TR-01-N hook to the roof sheet with two bolts &amp; nuts</p> 	<p><b>2</b></p> <p>Fix the solar panels to the hooks with mid clamps in the inner part</p> 	<p><b>3</b></p> <p>Fix the solar panels to the hooks with end clamps at the end of panel</p> 	<p><b>4</b></p> <p>Finished installation</p> 
---	--	--	--



# Thin Film Clamps

Approved by Canadian Solar and First Solar

Thin Film Clamps especially for:

1. First Solar Series 4 Modules;
2. Canadian Solar CS6X-P-FG;
3. Trina Solar Duomax TSM-PEG14.



## Brief Introduction

- Installation Site: Pitched or Flat Tin Roof;
- Max. Building Height: up to 65ft(22m), customized available;
- Max. Wind Speed: **60** m/s;
- Snow Load: **1.4** KN/m<sup>2</sup>;
- Material: Aluminum 6005-T5 & Stainless Steel 304;
- Warranty: **10** years warranty; **25** years service life.

## Computer simulation

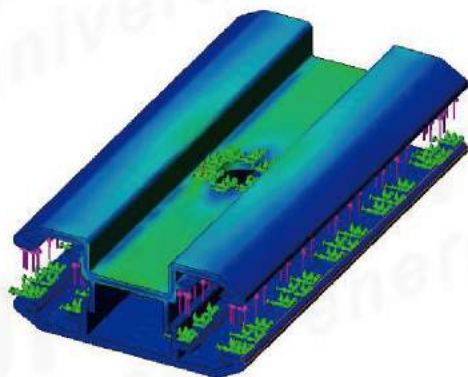

Thin Film Middle Clamp Stress Nephogram

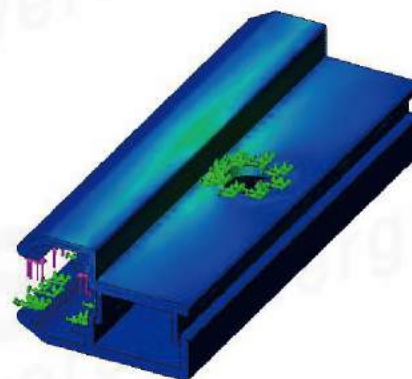
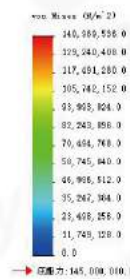

Thin Film End Clamp Stress Nephogram



## Description



UI-IC-Type3



UL Certified EPDM

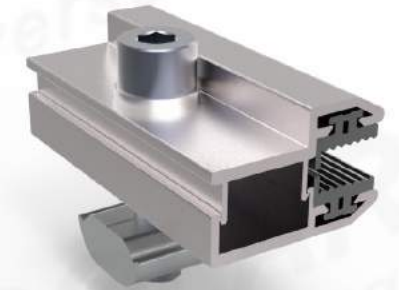

UI-EC-Type3

Item NO.	Spec.	Material	Surface	Length
UI-IC-Type3	Thin Film Middle Clamp	AL6005-T5,SUS304 & EPDM	Anodized	70/80/90/100/130mm or customized
UI-EC-Type3	Thin Film End Clamp	AL6005-T5,SUS304 & EPDM	Anodized	70/80/90/100/130mm or customized

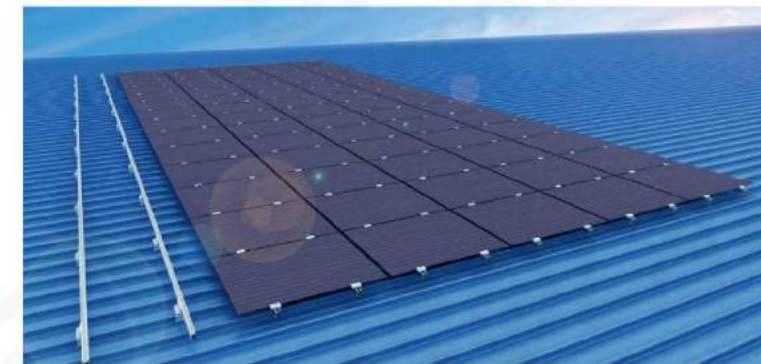

## Brief Installation Guide

1. Install the clamps to the roof sheet
2. Fix the rail to the clamp by the rail cross connector
3. Put the panels onto the rails and fix with mid clamps and end clamps
4. Finished the installation



# Aluminum Ballasted Mounting

Aluminum Ballasted Mounting II is designed with great flexibility both for the residential and commercial flat roof solar systems. Small and light weight to lessen the roof pressure.



3D Study



## Components Parts

<p><b>A</b> <b>UI-IC-II</b></p> <p>◆ Description Mid clamp, Al 6005-T5&amp; SUS 304</p> <p>◆Function Fix panel on the rail in the inner part</p>	<p><b>B</b> <b>UI-EC-II</b></p> <p>◆ Description End clamp, Al 6005-T5&amp; SUS 304</p> <p>◆Function Fix panel on the rail at the end of panel</p>	<p><b>C</b> <b>UI-SR-II</b></p> <p>◆ Description Triangle Frame 525mm</p> <p>◆Function Support Triangle Frame</p>
<p><b>D</b> <b>UI-TF-II</b></p> <p>◆ Description Triangle fixing components</p> <p>◆Function Connect triangle frame</p>	<p><b>E</b> <b>UI-BS-II</b></p> <p>◆ Description Ballasted Support Frame, Al6005-T5</p> <p>◆Function Fix onto the flat roof to support the solar panels</p>	

## Brief Introduction

- Installation Site: Flat roof
- Module Angle: **10-60** degrees
- Max. Building Height: up to 65ft(22m), customized available;
- Max. Wind Speed: **60**m/s;
- Snow Load: **1.4** KN/m<sup>2</sup>
- Material: Aluminum 6005-T5 & Stainless Steel 304;
- Warranty: **10** years warranty; **25** years service life.

## Brief Installation Guide

<p><b>1</b> Connect and fix the adjacent UI-BS II with Triangle fixing components</p>	<p><b>2</b> Fix the structure to the flat roof by the ballasted weight and fix the panel to the structure with clamps</p>	<p><b>3</b> Fix the end clamps</p>	<p><b>4</b> Finished the installation</p>

## Packing





# Flat Tin Roof Mounting

Uisolar Flat tin roof mounting was designed to meet the adjustable tilt angles' need. Adjustable tilt angles available make the system to get the best efficiency.



## Components Parts

 <p><b>UI-IC</b>                  ◆ Description                  Mid clamp, Al 6005-T5&amp; SUS 304                  ◆Function                  Fix panel on the rail in the inner part</p>	 <p><b>UI-EC</b>                  ◆ Description                  End clamp, Al 6005-T5&amp; SUS 304                  ◆Function                  Fix panel on the rail at the end of panel</p>	 <p><b>UI-R</b>                  ◆ Description                  Rail, Al 6005-T5                  ◆Function                  Supports panels</p>
 <p><b>UI-AD-FL</b>                  ◆ Description                  Front Leg, Al 6005-T5                  ◆Function                  Support Rail</p>	 <p><b>UI-AD-RL</b>                  ◆ Description                  Adjustable Rear Leg, Al 6005-T5                  ◆Function                  Support Rail</p>	

Adjustable Rear Leg	Specification	Adjustable Angle
	UI-RL-10/15	10~15 degree
	UI-RL-15/30	15~30 degree
	UI-RL-30/60	30~60 degree
	UI-RL-20/40	20~40 degree

Connection of Front Leg

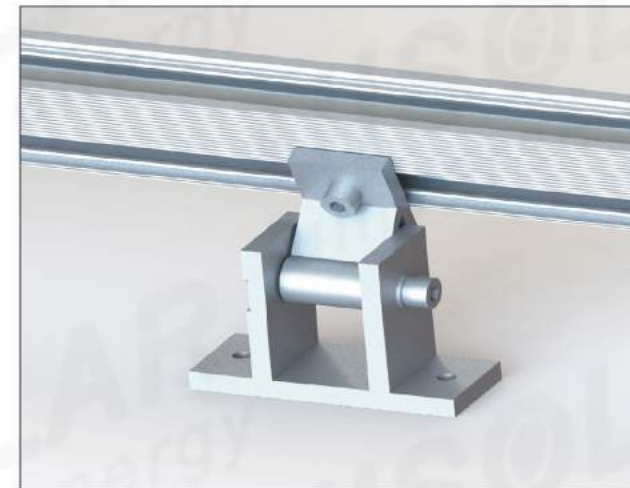



Connection of Rear Leg



## Brief Introduction

- Installation Site: Flat roof, open field
- Adjustable Tilt Angle : **10-60** degrees
- Max. Building Height: up to 65ft(22m), customized available;
- Max. Wind Speed: **60** m/s;
- Snow Load: **1.4** KN/m<sup>2</sup>
- Material: Aluminum 6005-T5 & Stainless Steel 304;
- Warranty: **10** years warranty; **25** years service life.

## Brief Installation Guide

<p><b>1</b> Fix the Front leg(UI-AD-FL) to the roof sheet with two screws</p> 	<p><b>2</b> Fix the Rear leg(UI-AD-RL) to the roof sheet with two screws</p> 	<p><b>3</b> Fix the solar rails to the front leg and rear leg</p> 	<p><b>4</b> Put solar panels onto rails and fix with clamps</p> 
---	--	---	---



## » Standing Seam Roof Kit SS05

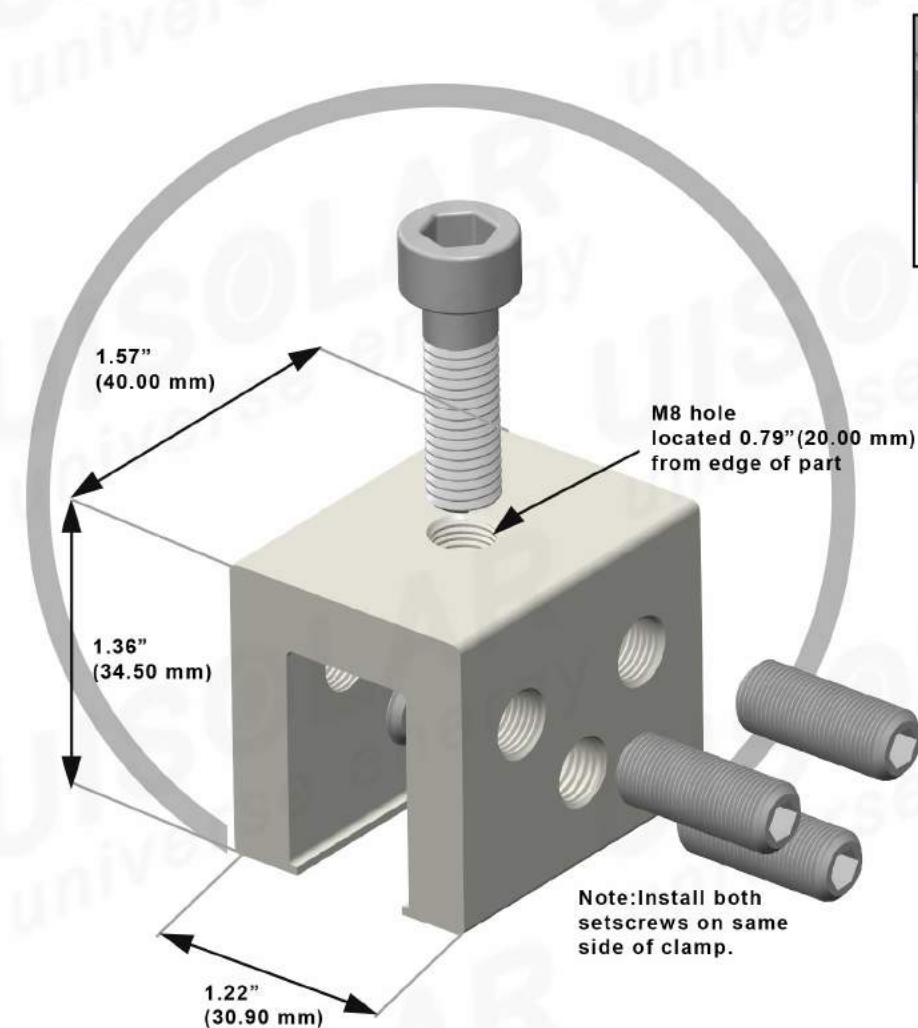

Application Roof

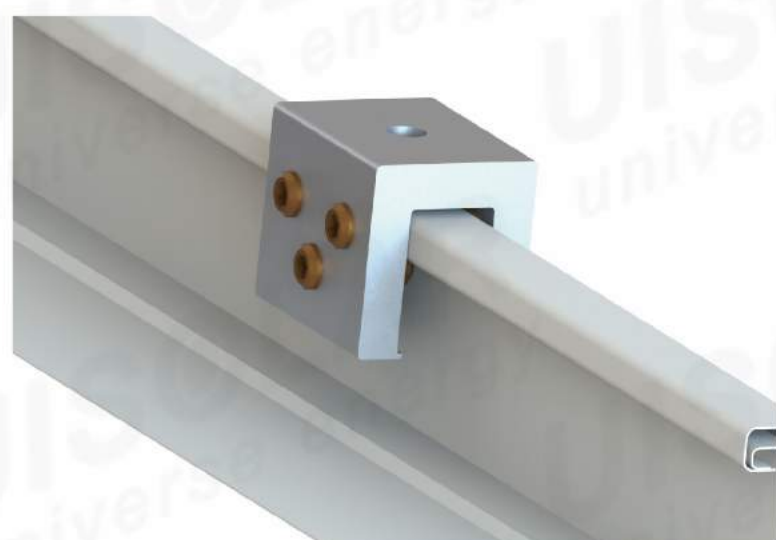

### Advantage of SS05

1. Easier installation
2. Lower cost
3. Wide application

## » Aluminum Triangle mounting





# Solar Aluminum Carport Mounting

With great flexibility, the Solar Aluminum Carport can be applied for both commercial and residential areas. The carport capacity can be customized as per customers' request. The whole structure is made of Aluminum and fastener will be stainless steel.









## Brief Introduction

- Installation Site: Ground, Open field;
- Module Angle: **0-20**degrees;
- Max.Building Height: Customized;
- Snow Load: **1.4** KN/m<sup>2</sup>;
- Max Wind Speed: **60**m/s;
- Material: Aluminum 6005-T5& SUS 304;
- Warranty: **10** years warranty; **25** years service life.

## Brief Installation Guide

<b>1</b>	<b>2</b>	<b>3</b>	<b>4</b>
Unfold the UI-Pole & Fix the UI-Pole to the UN-Beam	Set up the assembled UI-Pole and the UI-Beam	Fix the UI-RC11 to the UI-Beam	Solar panel installation

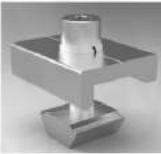
## Components Parts

<p><b>A</b></p>  <p><b>UI-Pole</b></p> <ul style="list-style-type: none"> <li>◆ Description Pole, Al6005-T5</li> <li>◆ Function This pole support the whole carport brackets</li> </ul>	<p><b>B</b></p>  <p><b>UI-Beam</b></p> <ul style="list-style-type: none"> <li>◆ Description Beam, Extruded Aluminum file, Al 6005-T5</li> <li>◆ Function To connect poles</li> </ul>	
<p><b>C</b></p>  <p><b>UI-RC11</b></p> <ul style="list-style-type: none"> <li>◆ Description Rail, Al6005-T5</li> <li>◆ Function The frame support the solar panel</li> </ul>	<p><b>D</b></p>  <p><b>UI-RS</b></p> <ul style="list-style-type: none"> <li>◆ Description Rail Splice, Al6005-T5 &amp; SUS304</li> <li>◆ Function Extend the rail to the required length</li> </ul>	
<p><b>E</b></p>  <p><b>UI-Clamp-F</b></p> <ul style="list-style-type: none"> <li>◆ Description Clamp, Al6005-T5&amp;SUS304</li> <li>◆ Function Fix the rail to the beam</li> </ul>	<p><b>F</b></p>  <p><b>UI-EC (5A)</b></p> <ul style="list-style-type: none"> <li>◆ Description End Clamp, Al 6005-T5&amp; SUS 304</li> <li>◆ Function Fix panel on the rail at the end of panel</li> </ul>	<p><b>G</b></p>  <p><b>UI-IC (5A)</b></p> <ul style="list-style-type: none"> <li>◆ Description Mid Clamp, Al 6005-T5&amp; SUS 304</li> <li>◆ Function Fix panel on the rail in the inner part</li> </ul>

## Project Pictures





# Four Poles Carport Mounting

Four Poles Carport Mounting System is designed to meet the need of wind-resistance, waterproof and scarping the car door.  
 The whole system is made of Aluminum and Q235.



## Brief Introduction

- Installation Site: Open Field, Earth or concrete ground;
- Module Angle: **0-10**degrees;
- Max.Building Height: Customized;
- Max wind speed : **60**m/s
- Snow Load: **1.2**KN/m<sup>2</sup>;
- Material: Aluminum 6005-T5 & Q235;
- Warranty: **10**years warranty; **25**years service life.

## Components Parts

<p><b>A UI-Pole</b></p> <p>◆ Description Pole, Al 6005-T5</p> <p>◆ Function This pole support the whole carport brackets</p>	<p><b>B UI-Beam</b></p> <p>◆ Description Beam, Al 6005-T5</p> <p>◆ Function To connect poles</p>	<p><b>C UI-WD-R</b></p> <p>◆ Description Waterproof , Al6005-T5</p> <p>◆ Function Side leakage proof plate</p>
<p><b>D UI-WS</b></p> <p>◆ Description Waterproof sheet, Q235</p> <p>◆ Function To play the function of waterproof</p>	<p><b>E UI-R</b></p> <p>◆ Description Rail, Al 6005-T5</p> <p>◆ Function The frame support the solar panel</p>	<p><b>F UI-R-SP</b></p> <p>◆ Description UI-Rail Splice, Al 6005-T5</p> <p>◆ Function Connect the rails</p>
<p><b>G UI-IC</b></p> <p>◆ Description Mid Clamp, Al 6005-T5&amp; SUS 304</p> <p>◆ Function Fix panel on the rail in the inner part</p>	<p><b>H UI-EC</b></p> <p>◆ Description End Clamp, Al 6005-T5&amp; SUS 304</p> <p>◆ Function Fix panel on the rail at the end of panel</p>	<p><b>I UI-Clamp</b></p> <p>◆ Description Fixing clamp, Al6005-T5&amp; SUS 304</p> <p>◆ Function Fix the rail to the support rack</p>

## Brief Installation Guide

<p><b>1</b> Put the pole into the ground</p>	<p><b>2</b> Set up the assembled UI-Pole and the UI-Beam</p>	<p><b>3</b> Fix the UI-R2 to the UI-Beam</p>	<p><b>4</b> Solar panel installation</p>

## Advantages

- 01** Compare to the steel supports, it is lighter and easier to transport and install
- 02** Easy installation: cutting and drilling are arranged before delivery, which greatly saves time and labor costs
- 03** Quality assurance : Aluminum structure make it to be superior corrosion resistance



# ST2 Pile Ground Mounting

St2 pile ground mounting is usually applicable to the open mountainous irregular land field and solve the East-west and South-North direction mountains problem. With a strong structure .

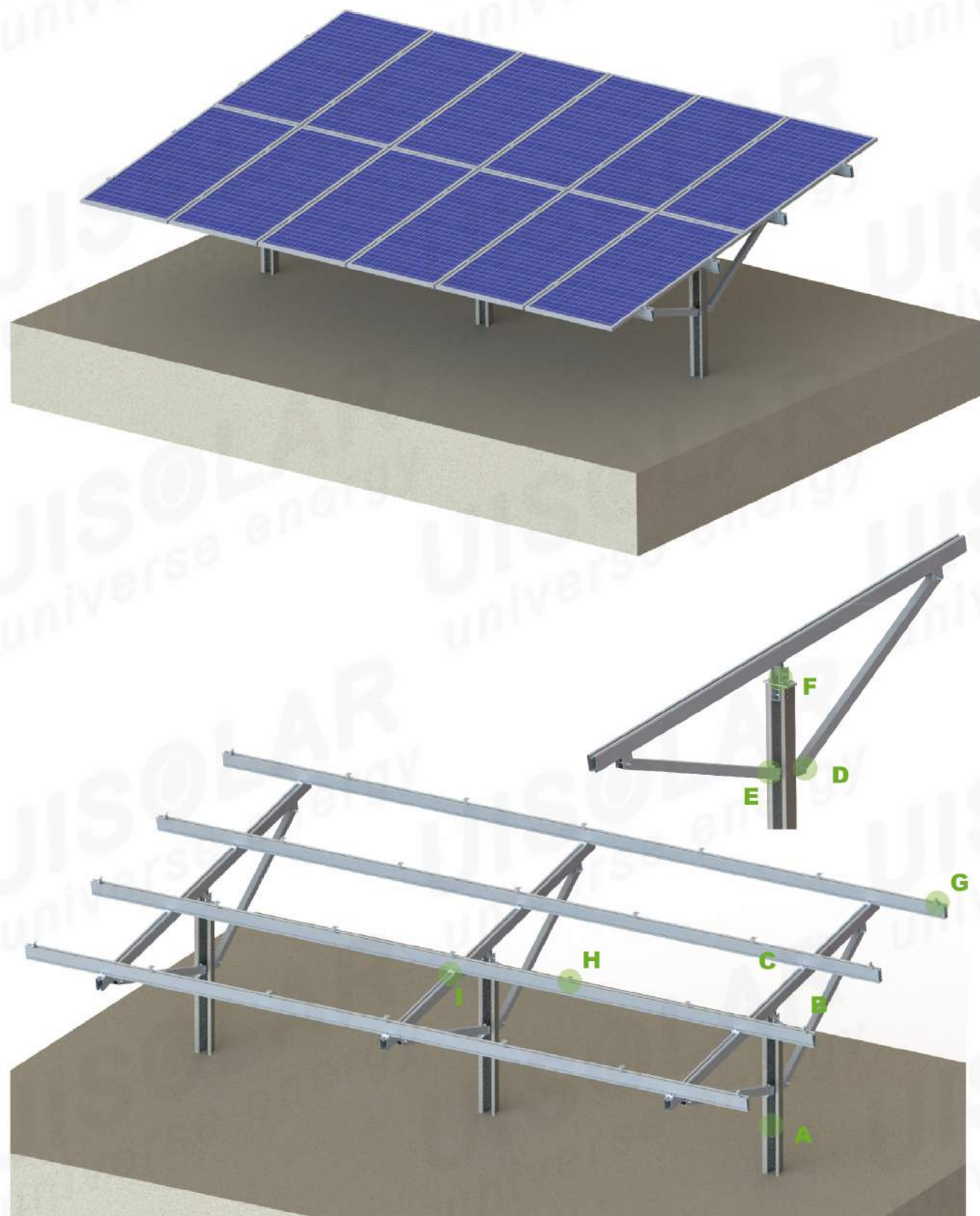

## Components Parts

<b>A</b> <b>UI-ST2</b> ◆ Description Main pole, Q235 ◆Function Support on the ground	<b>B</b> <b>UI-ST3F-Rack</b> ◆ Description Support Rack, Al 6005-T5 ◆Function Support the rail and panel	<b>C</b> <b>UI-ST2-SP   &amp; II</b> ◆ Description Joint-A/ B, Al 6005-T5& SUS 304 ◆Function Connect the Front support pipe and the main pole
<b>D</b> <b>UI-R</b> ◆ Description Rail, Extruded Aluminum Profile, Al6005-T5 ◆Function The frame supports the solar panel	<b>E</b> <b>UI-ST2-LA</b> ◆ Description Joint-C, Al 6005-T5 ◆Function Connect the footbase and main pole	<b>F</b> <b>UI-ST3F-FLA</b> ◆ Description Al 6005-T5& SUS 304 ◆Function Connect the rack to the main pole
<b>G</b> <b>UI-EC</b> ◆ Description End Clamp, Al 6005-T5& SUS 304 ◆Function Fix panel on the rail at the end of panel	<b>H</b> <b>UI-IC</b> ◆ Description Mid Clamp, Al 6005-T5& SUS 304 ◆Function Fix panel on the rail in the inner part	<b>I</b> <b>UI-Clamp</b> ◆ Description Fixing clamp, Al6005-T5 ◆Function Fix the rail to the support rack

## Brief Introduction

- Installation Site: Open field/ Ground;
- Module Angle: **0-45** degrees;
- Max. Wind Speed: **60** m/s;
- Snow Load: **1.4** KN/m<sup>2</sup>;
- Material: Aluminum 6005-T5&Q235;
- Warranty: **10** years warranty; **25** years service life.

## Advantages

- 01 Reduce the pole QTY and it is more convenient to maintaining
- 02 It has more space for the foundation
- 03 Application widely and fine tune is available

## Brief Installation Guide

<b>1</b> Fix the steel pole pile into the ground	<b>2</b> Fix the pre-assembled support rack to the foot bases	<b>3</b> Fix the rail to the support rack and do proper adjustment	<b>4</b> Solar panel installation



# ST3 Aluminum Ground Mounting

ST3 Aluminum Ground Mounting is usually applicable to the open field, not only for residential projects, but also for the big commercial projects.

It is featured with light weight, strong and powerful structure and recyclable materials, the pre-assembled support rack save your time and cost.

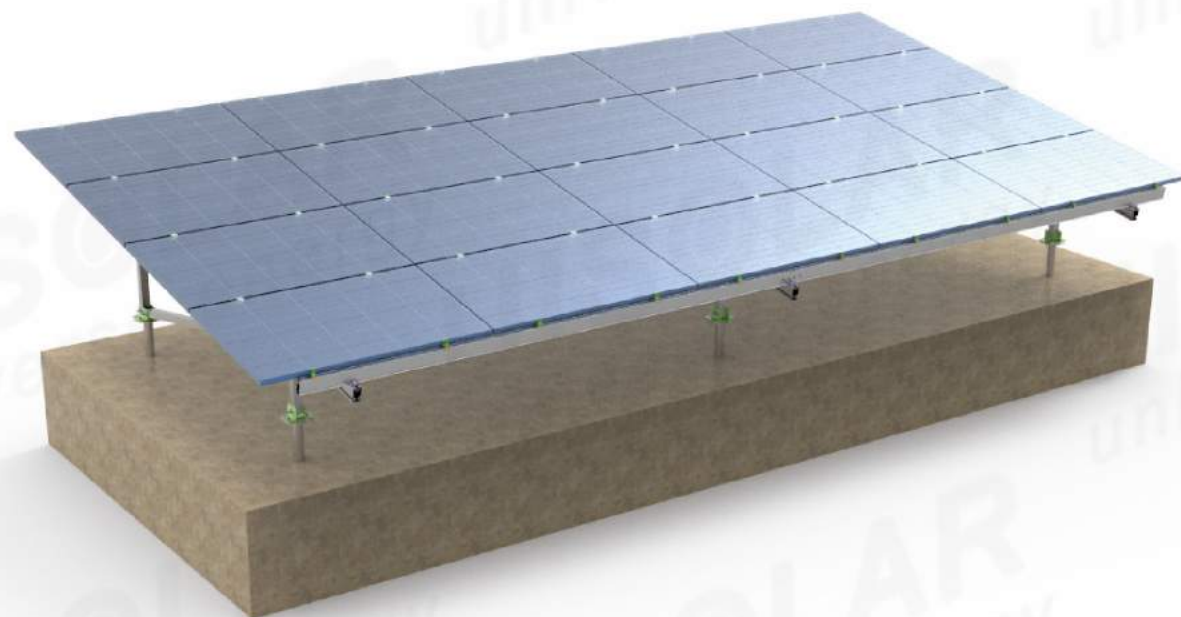

## Brief Introduction

- Installation Site: Open field/ Ground;
- Module Angle: **0-60**degrees;
- Max. Wind Speed: **60**m/s;
- Snow Load: **1.4** KN/m<sup>2</sup>;
- Material: Aluminum 6005-T5;
- Warranty: **10** years warranty; **25** years service life;
- Patent: ZL 2014 2 0442042.6.

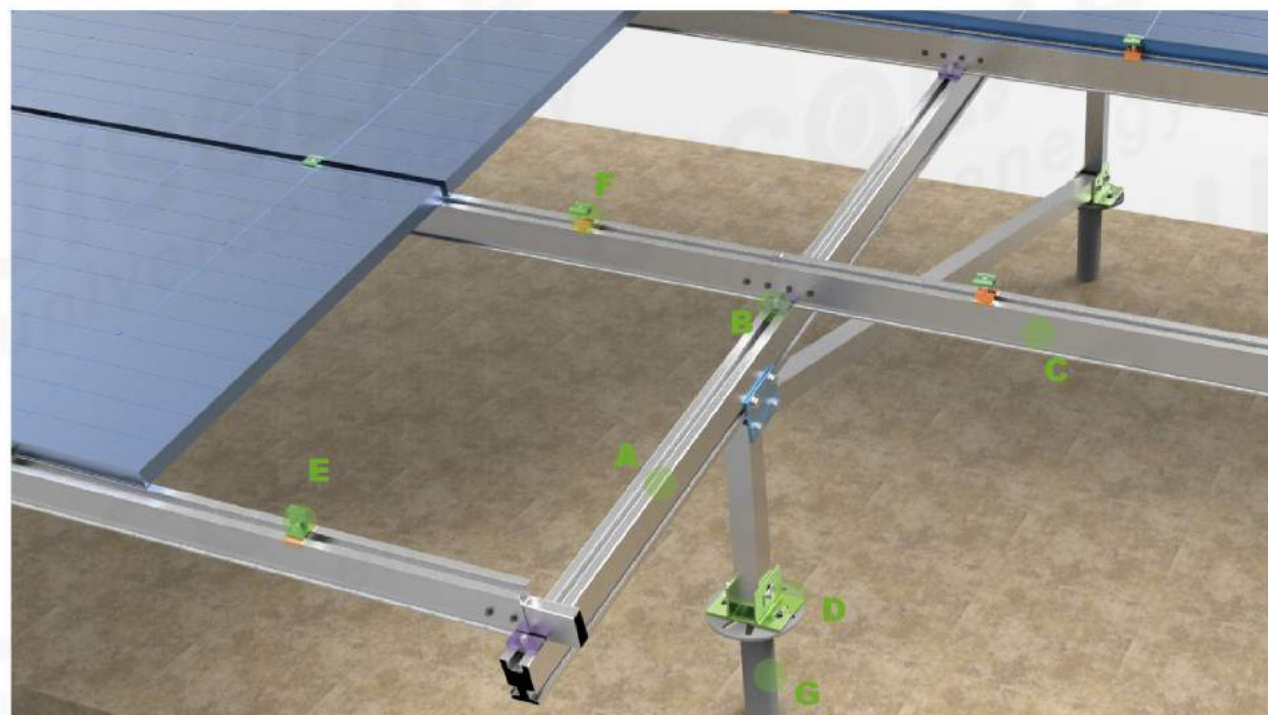

## Components Parts

<b>A</b>  <b>UI-Rack</b> ◆ Description Beam, Front&rear leg, Al 6005-T5 ◆Function Support the frame	<b>B</b>  <b>UI-Clamp</b> ◆ Description Fixing Clamp, Al 6005-T5 ◆Function Fix the rail to the support rack	
<b>C</b>  <b>UI-R</b> ◆ Description Rail, Al 6005-T5 ◆Function The frame support the solar panel	<b>D</b>  <b>UI-FB</b> ◆ Description Foot base, Al 6005-T5 ◆Function Fix front leg&rear leg on base	
<b>E</b>  <b>UI-EC</b> ◆ Description End Clamp, Al 6005-T5& SUS 304 ◆Function Fix panel on the rail at the end of panel	<b>F</b>  <b>UI-C</b> ◆ Description Mid Clamp, Al 6005-T5& SUS 304 ◆Function Fix panel on the rail in the inner part	<b>G</b>  <b>Ground Screw</b> ◆ Description Ground Screw, Q235 ◆Function The basis of the system

## Advantages



The clamps with locking block can prevent the rail slide.

The ripples on the foot base can make it be anti-skid and stronger.

Highly pre-assembled, save cost and time.

## Brief Installation Guide

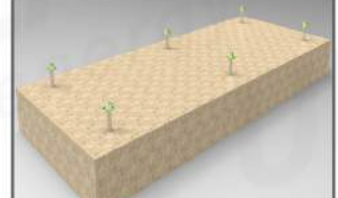
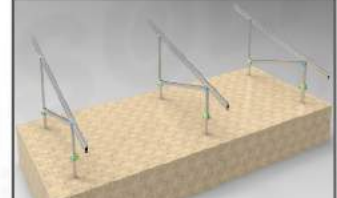
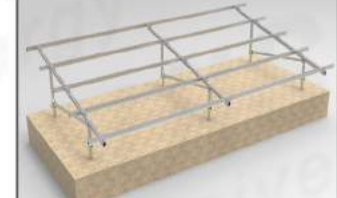
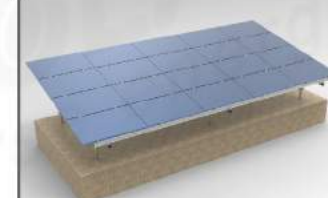
<b>1</b> Fix the Leg base to the ground screw	<b>2</b> Fix the pre-assembled support rack to the foot bases	<b>3</b> Fix the rail to the support rack and do proper adjustment	<b>4</b> Solar panel installation
			



# Solar Farm

Solar farm has been a classic applications of solar energy. Solar farm not only generate the energy but also protect plants from the extreme weather and gather the heat for fast growing.



## Brief Installation Guide

- 1

Position the Y pole dig into the ground

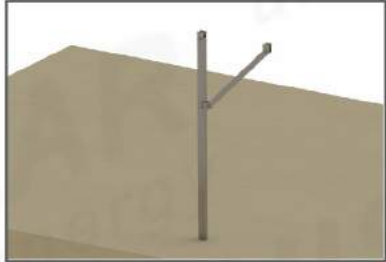
- 2

Position the W pole dig into the ground

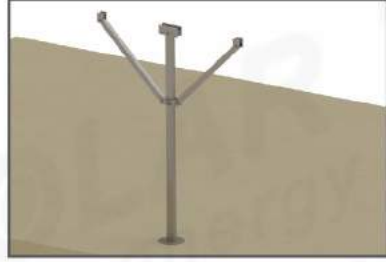
- 3

Connect the Y pole and W pole

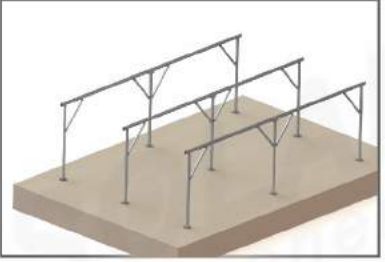
- 4

Install the triangle structure on the beam

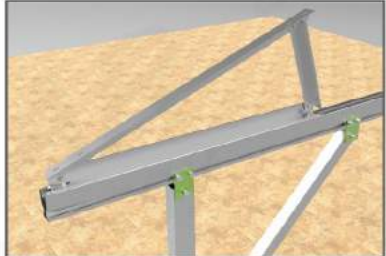
- 5

Put the preassembled Triangle support to the pole and beam

- 6

Put rails onto the triangle support and fix the panel adn calmps



## Components Parts

<p><b>A</b></p>  <p><b>UI-AR-LA</b></p> <ul style="list-style-type: none"> <li>◆ Description Leg Cap, Q235</li> <li>◆ Function Fix Legs</li> </ul>	<p><b>B</b></p>  <p><b>UI-AR Pole (Y)</b></p> <ul style="list-style-type: none"> <li>◆ Description AR Pole, Al6005-T5</li> <li>◆ Function This pole support the whole solar farm brackets</li> </ul>	<p><b>C</b></p>  <p><b>UI-AR Pole (W)</b></p> <ul style="list-style-type: none"> <li>◆ Description AR Pole, Al6005-T5</li> <li>◆ Function This pole support the whole solar farm brackets</li> </ul>
<p><b>D</b></p>  <p><b>UI-AR Beam</b></p> <ul style="list-style-type: none"> <li>◆ Description Beam, Extruded Aluminum Profile, Al 6005-T5</li> <li>◆ Function To Connect AR poles</li> </ul>	<p><b>E</b></p>  <p><b>UI-AR Triangle support</b></p> <ul style="list-style-type: none"> <li>◆ Description Triangle support, aluminum 6005-T5</li> <li>◆ Function Fix angle and supports the rail</li> </ul>	<p><b>F</b></p>  <p><b>UI-AR-SP</b></p> <ul style="list-style-type: none"> <li>◆ Description Beam Splice, Extruded Aluminum Profile, Al 6005-T5</li> <li>◆ Function To Connect Beam</li> </ul>
<p><b>G</b></p>  <p><b>UI-R</b></p> <ul style="list-style-type: none"> <li>◆ Description Rail, Extruded Aluminum Profile, Al6005-T5</li> <li>◆ Function The frame supports the solar panel</li> </ul>	<p><b>H</b></p>  <p><b>UI-IC</b></p> <ul style="list-style-type: none"> <li>◆ Description Mid clamp, Al 6005-T5&amp; SUS 304</li> <li>◆ Function Fix panel on the rail in the inner part</li> </ul>	<p><b>I</b></p>  <p><b>UI-EC</b></p> <ul style="list-style-type: none"> <li>◆ Description End clamp, Al 6005-T5&amp; SUS 304</li> <li>◆ Function Fix panel on the rail at the end of panel</li> </ul>

## Brief Introduction

- Installation Site: open field
- Module Angle : 0-60 degrees
- Max. Wind Speed: 60 m/s;
- Snow Load: 1.4 KN/m<sup>2</sup>
- Material: Aluminum 6005-T5 & Q235;
- Warranty: 10 years warranty; 25 years service life.

## Advantages

- 01 Highly pre-assembled components before delivery significantly make installation cost-savings
- 02 Easy installation with humanized user guide
- 03 Reliable calculation and testing make the system to be more economic and safer



## » Ground Screw

Uisolar Ground Screw is made of Q235 material. We have flange top and tube top types with different specification. Our standard thickness is 3mm,3.5mm and 2.75mm and length with 1200mm, 1600mm, 1800mm,2000mm.The length and size could also be customized. It can be used for many kinds of application, like Timer-Frame Construction; Advertising and traffic systems;Urban, Garden and Landscape Constraction; Hall and container Construction; Fencing Systems,Solar systems; Flag Poles & Banners etc.



### ■ Brief Introduction

- Material:Q235
- Surface:Hot dip galvanization
- Thickness:3.0mm/2.75mm/3.5mm
- Series:Flange Top, Tube Top
- Warranty: **10** years warranty; **25** years service life.



### ■ Advantages

- 01 Compatibility with all type of structures.**  
Our technical department will adapt the head of our ground screw piles to whatever the need of the customer is.
- 02 Foundation solution concrete free**  
No need of Concrete base.
- 03 Surrounding areas remains unspoiled**  
The special configuration of our products allows the insertion without performing land preparation works, which allows a significant cost reduction.
- 04 Easy removal simple and easy to relocate**  
One of the main advantages of our ground screw piles is the possibility of removing them, reducing the environmental impact and minimizing the removing costs.

### ■ Ground Screw



### ■ Specification

NO	Code1	Surface	Material	H(mm)	D(mm)	Galvanized Surface	Thickness
01	F76×L— 2	Hot Galvanized	Q235	Customized	76	≥ 80 μm	3.5mm/ 2.75mm/ 3.0mm
02	F76×L— 4			Customized	76	≥ 80 μm	
03	F76×L			Customized	76	≥ 80 μm	
04	N76×L			Customized	76	≥ 80 μm	
05	F76×L— A			Customized	76	≥ 80 μm	
06	F76×L— U			Customized	76	≥ 80 μm	

### ■ Flange Type

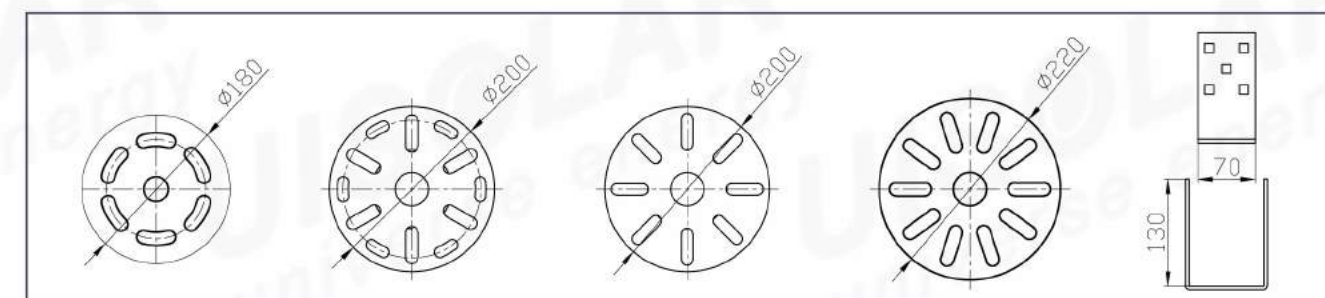

### ■ Tube Type

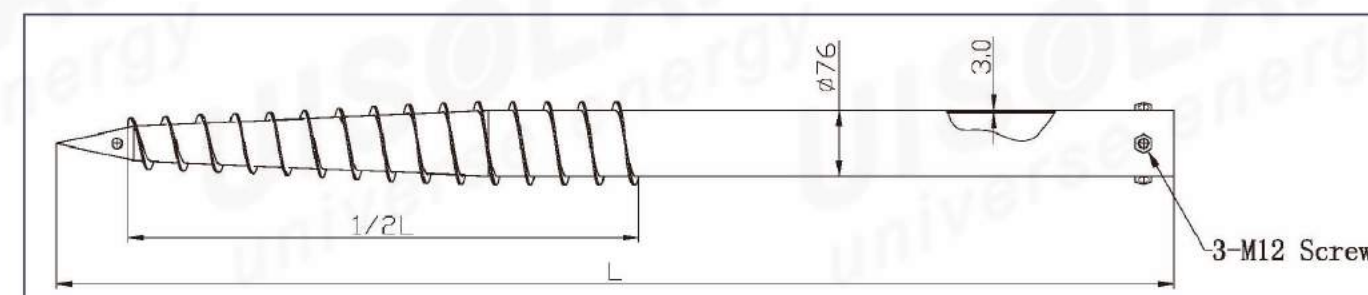



■ Production Process



■ Ground Screw Application

**APPLICATIONS**

Versatile. individual. flexible

**T**imer-Frame Construction



Ideal for sustainable, efficient and long-term building ideas made with or entirely of wood.

**A**dvertising and traffic systems



The attractive and cost-efficient alternative thanks to quick and uncomplicated installation.

**U**rban, Garden and Landscape Construction



An ecologically and economically optimal and modern solution

**H**all and container Construction



Quick, flexible and economical: This is modern construction.

**F**encing Systems



The optimal solution for almost every terrain: fast, stable and professional.

**S**olar systems



Long-term environmental soundness and cost savings: The perfect foundation for every ground mounted system

**F**lag Poles & Banners



Easy Installation, efficiency and Flexibility



## Projects



Project size: 10MW  
Site Location: Japan  
Finished Time: 2016  
Project type: ST3 Aluminum Ground Mounting



Project size: 10MW  
Site Location: Mongolia  
Finished Time: 2018  
Project type: ST3 Aluminum Ground Mounting



Project size: 7MW  
Site Location: Japan  
Finished Time: 2014  
Project type: ST3 Aluminum Ground Mounting



Project size: 1MW  
Site Location: Japan  
Finished Time: 2015  
Project type: ST1 Steel Ground Mounting



Project size: 30MW  
Site Location: Netherland  
Finished Time: 2017  
Project type: ST3F Aluminum Ground Mounting



Project size: 8MW  
Site Location: Barbados  
Finished Time: 2014  
Project type: Concrete Roof Mounting



Project size: 600KW  
Site Location: Japan  
Finished Time: 2016  
Project type: Solar Farm



Project size: 350KW  
Site Location: Japan  
Finished Time: 2015  
Project type: Aluminum Carport



Project size: 2MW  
Site Location: Japan  
Finished Time: 2014  
Project type: ST1 Steel Ground Mounting



Project size: 8MW  
Site Location: Japan  
Finished Time: 2015  
Project type: Ballast Mounting



Project size: 700KW  
Site Location: Japan  
Finished Time: 2015  
Project type: ST1 Steel Ground Mounting



Project size: 3MW  
Site Location: China  
Finished Time: 2016  
Project type: Trapezoidal Roof Mounting



## » Certificate

## » PV Show

The collage displays several certification documents:

- IONet CERTIFICATE:** Issued by IONet, Inc. for Xi'an Universe Solar Technology Co., Ltd. regarding ISO 9001:2008 certification.
- SGS TEST REPORT:** Multiple reports from SGS, including one for ISO 9001:2008 and another for ISO 14001:2004.
- SPAD TEST REPORT:** Reports from SPAD (Solar Product Approval Department) for various solar panel models.
- Intertek Test Report:** A report for a lithium-ion battery pack (Li-ion) from Intertek.
- Certificate of Compliance:** Issued by the Testing Report of Xiamen Product Quality Supervision & Inspection Institute.
- Additional Test Reports:** Several other reports from the Testing Report of Xiamen Product Quality Supervision & Inspection Institute, including one with a graph showing a performance curve.

At the bottom of the collage, the following logos are displayed: **SGS**, **CE**, **ISO 9001**, and **UL**.





## » Packing and shipping



Container waiting area



Rail package



Beam assembly package



Container photos



Ground screw package



Steel frame package

## » Voice from our Clients



I want to do big realizations with your company --UISOLAR, because you are honest and quickly react to my needs-other firms in China are not like that.

Krzysztof from Poland



Thanks for you and your team's patient and professional support, you are always my first choice for China business.

Kevin from Singapore

